

SELF POWERED

LINE SEIKI



Automática Electrónica y Control, S.L. Lacy, 30 Acc. - 08202 Sabadell (Barcelona)  
Tel 937 207 066 Fax 937 209 999 www.automat-elec.es info@automatica.cat

# GC2/GH2/GM2/GS2 SERIES

- Lithium battery installed inside. Battery life 7 years(replaceable)
- Front Panel Protection IP54
- In Conformance to CE(EMC)
- RoHS compliant
- In Conformance to UL



- 6/8digits LCD display with 10.6mm height
- Panel Cut-out 50.0 x 25.0mm



## MODELS

### ● G□2 SERIES(GC2/GH2/GM2/GS2)

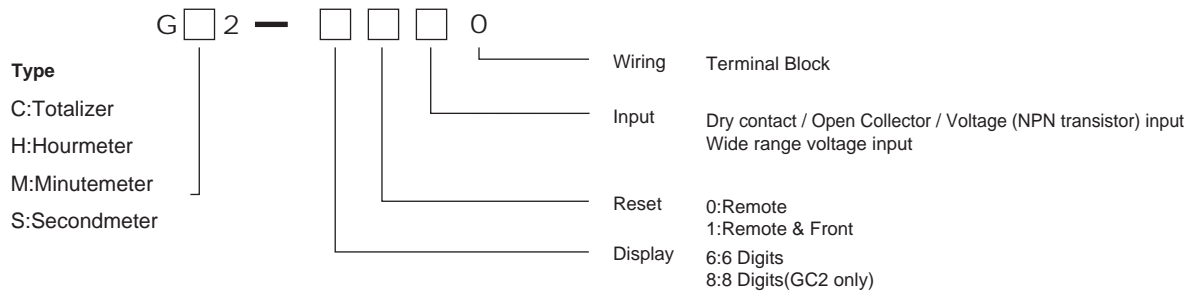

## SPECIFICATIONS

Type	GC2 Totalizer	GH2 Hourmeter	GM2 Minutemeter	GS2 Secondmeter
Display	6/8 digits, 7-segment LCD 10.6mm(H)			
No. of digit	0 - 999999/0 - 99999999		0.0 - 99999.9	
Spec of input	Max.count speed G□2-□□00 30Hz G□2-□□10 20Hz	Resolution 1count per 1/10 hour	Resolution 1count per 1/10 minute	Resolution 1count per 1/10 second

## MECHANICAL / ENVIRONMENTAL SPECIFICATIONS

Operating Temp.	-10 - +55°C(Non-freezing)
Storage Temp.	-20 - +65°C(Non-freezing)
Operating humidity	25 - 85%RH(Non-condensing)
Vibration / Shock Resistance	Operation : Double amplitude 0.3mm Frequency 10-55Hz X.Y.Z. Axis 100mm/s <sup>2</sup> Storage : Double amplitude 0.75mm Frequency 10-55Hz X.Y.Z. Axis 300mm/s <sup>2</sup>
Protection of front panel	IP54
Weight	60g (Battery included)
Wiring	Terminal type:14-22 AWG lead wires to be connected by screws.

## ELECTRICAL SPECIFICATIONS

<b>Input</b>	Dry Contact / Open Collector / Voltage (NPN transistor) Wide range voltage	L:<0.8V H:2 - 30V L:DC/AC 0 - 10V H:DC/AC 20 - 250VInput	Sink current 8 $\mu$ A impedance:300k $\Omega$
<b>Reset</b>	Front Reset Remote Reset Dry Contact / Open Collector / Voltage (NPN transistor) Wide range voltage	L:<0.8V H:2 - 30V L:DC/AC 0 - 10V H:DC/AC 20 - 250VInput	Sink current 8 $\mu$ A impedance:300k $\Omega$
<b>Reset pulse width</b>	6ms MIN.		
<b>Power source</b>	Lithium battery installed , Battery life 7 years (replaceable)		
<b>Noise Immunity</b>	Electrostatic Discharge	IEC-61000-4-2	8kV
	Radiated Electromagnetic Field	IEC-61000-4-3	10V/m
	EFT/B.I/O Leads	IEC-61000-4-4	1.0kV
<b>EMC standard</b>	EMI : EN50081-2 EMS: EN50082-2		

## DIMENSIONS

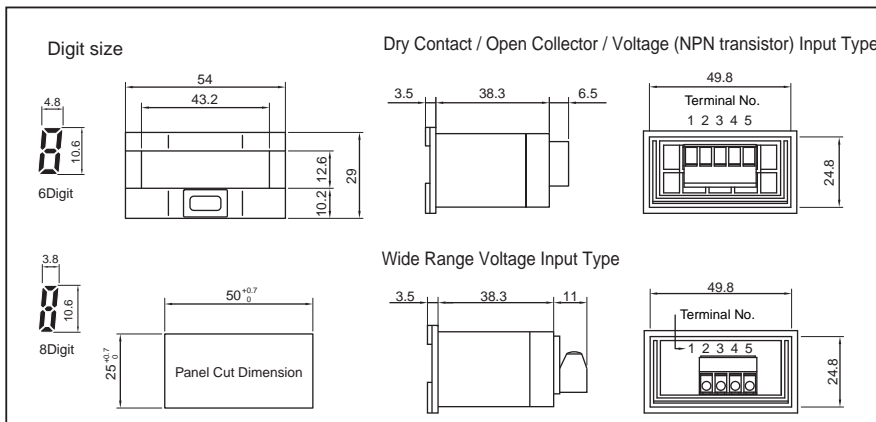

## MOUNTING

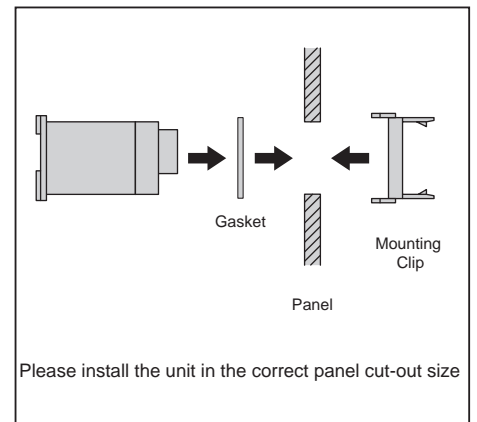

## WIRING

<G□2-□□00>

Dry Contact / Open Collector / Voltage (NPN transistor) Input Type

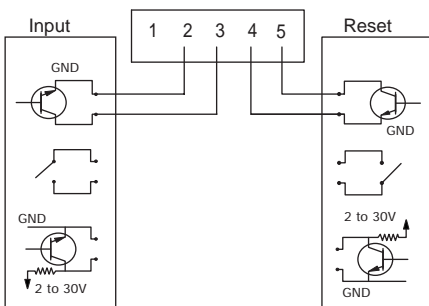

<G□2-□□10>

Wide Range Voltage Input Type

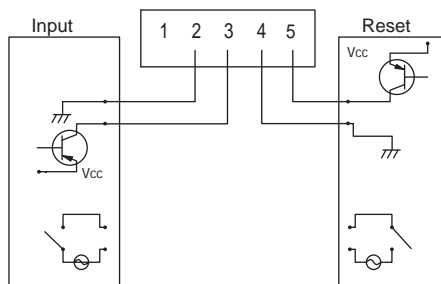

### ● Input Theory

<G□2-□□00>

Dry Contact / Open Collector / Voltage (NPN transistor) Input Type

Input terminal No.3 : Count at Hi  $\rightarrow$  Lo

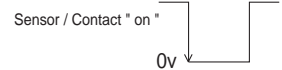

<G□2-□□10>

Wide Range Voltage Input

Input terminal No.3 : Count at Lo  $\rightarrow$  Hi

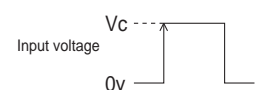

Automática Electrónica y Control, S.L. Lacy, 30 Acc. - 08202 Sabadell (Barcelona)  
Tel 937 207 066 Fax 937 209 999 www.automatca-elec.es info@automatca.cat

This catalog was last revised May, 27, 2010.

\*Subject to change without prior notice.

All Rights Reserved, Copyright © 2010, LINE SEIKI CO., LTD.



LINE SEIKI CO., LTD.

Address : 37-7, Chuo-Cho, 2-Chome, Meguro-ku  
Tokyo 152-0001 JAPAN

Contacts : Tel: +81-3-3716-5151 Fax: +81-3-3710-4552

E-mail: webtrade@line.co.jp

URL : http://www.line-seiki.com