

## ARC 050

ROOF MOUNT AIR CONDITIONERS

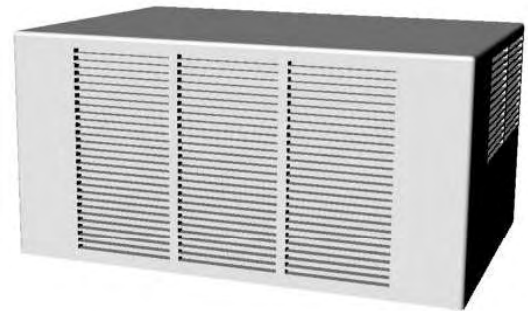
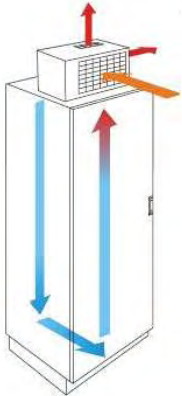

Features	Unit	ARC050.000
Power supply	V/Hz	230V/1ph/50-60
Dimensions HxDxW	mm	250x350x500
Cooling capacity A35A35	W	490/520
Cooling capacity A35A50	W	360/380
Starting current	A	6.8/6.9
Max running current	A	1.9/2.2
Noise level	dB(A)	67
Absorbed electric power A35A35	W	360/420
Protection degree EN60529/1 enclosure inside	-	IP54
Protection degree EN60529/1 ambient inside	-	IP34
Weight	kg	22
Colour	-	RAL 7035

## DRILLING TEMPLATE

VIEW FROM EXTERNAL OF ELECTRICAL BOX

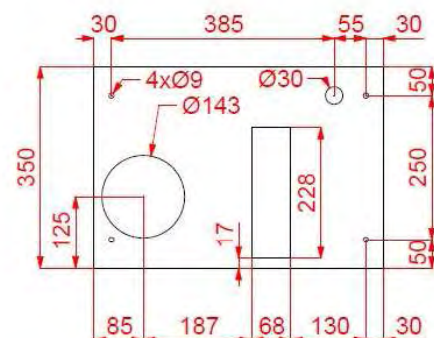
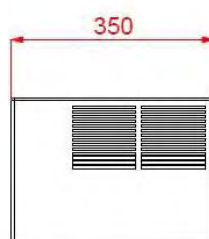
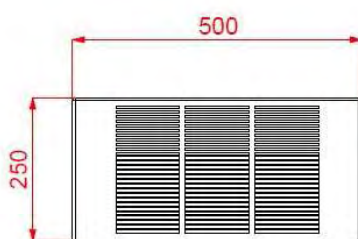

## ARC 100/150/170

ROOF MOUNT AIR CONDITIONERS

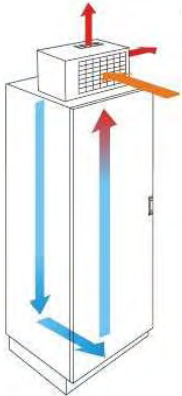

Features	Unit	ARC100.000	ARC150.000	ARC170.000
Power supply	V/Hz	230V/1ph/50-60	230V/1ph/50-60	230V/1ph/50-60
Dimensions HxWxD	mm	300x400x600	300x400x600	300x400x600
Cooling capacity A35A35	W	1000/1060	1450/1520	1650/1730
Cooling capacity A35A50	W	750/780	1090/1130	1240/1290
Starting current	A	11.5/12.7	16.2/16.4	20.0/20.0
Max running current	A	2.9/3.5	4.0/4.8	5.2/6.2
Noise level	dB(A)	70	70	70
Absorbed electric power A35A35	W	570/670	785/925	1000/1190
Protection degree EN60529/1 enclosure inside	-	IP54	IP54	IP54
Protection degree EN60529/1 ambient inside	-	IP34	IP34	IP34
Weight	kg	37	41	41
Colour	-	RAL 7035	RAL 7035	RAL 7035

### DRILLING TEMPLATE

VIEW FROM EXTERNAL OF ELECTRICAL BOX

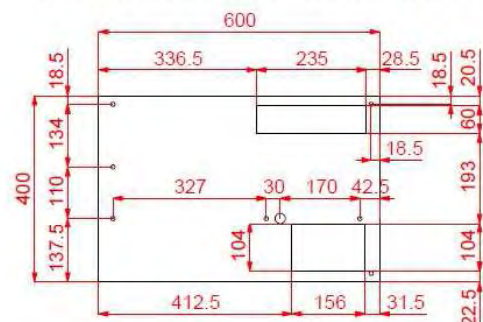
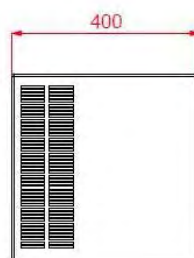
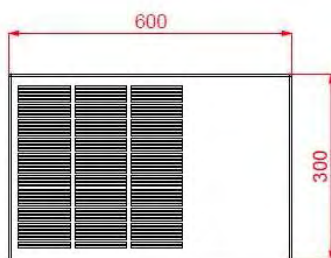

## ARC 200

ROOF MOUNT AIR CONDITIONERS

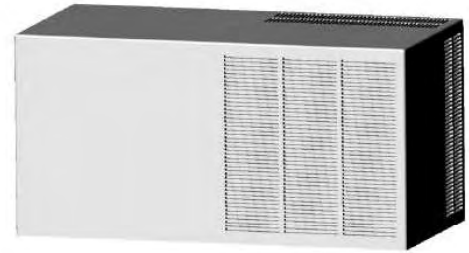
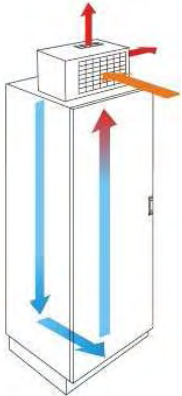

Features	Unit	ARC200.000
Power supply	V/Hz	230V/1ph/50-60
Dimensions HxDxW	mm	400x402x800
Cooling capacity A35A35	W	2000/2100
Cooling capacity A35A50	W	1500/1560
Starting current	A	23.7/24.2
Max running current	A	5.0/6.1
Noise level	dB(A)	65
Absorbed electric power A35A35	W	1050/1272
Protection degree EN60529/1 enclosure inside	-	IP54
Protection degree EN60529/1 ambient inside	-	IP34
Weight	kg	54
Colour	-	RAL 7035

### DRILLING TEMPLATE

VIEW FROM EXTERNAL OF ELECTRICAL BOX

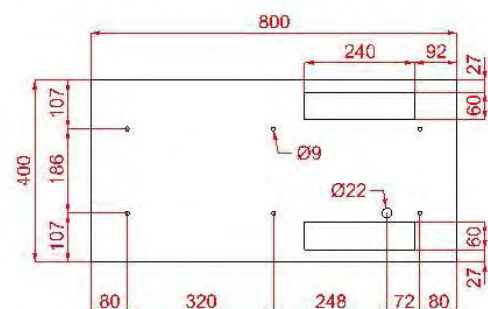
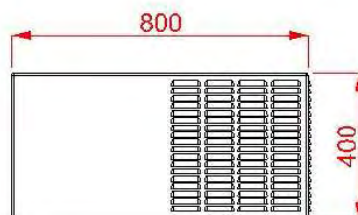
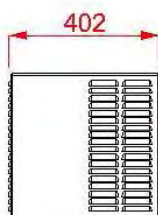



## ARC 300/400

ROOF MOUNT AIR CONDITIONERS

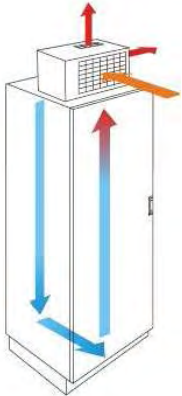

Features	Unit	ARC300.410	ARC300.420	ARC400.410	ARC400.420
Power supply	V/Hz	400V/3ph/50	400V/3ph/60	400V/3ph/50	400V/3ph/60
Dimensions HxDxW	mm	400x402x800	400x402x800	400x402x800	400x402x800
Cooling capacity A35A35	W	2800	2940	3800	3990
Cooling capacity A35A50	W	2100	2180	2850	2964
Starting current	A	10.5	10.5	14.6	15.2
Max running current	A	2	2	2.7	2.7
Noise level	dB(A)	65	65	65	65
Absorbed electric power A35A35	W	1540	1800	2090	2450
Protection degree EN60529/1 enclosure inside	-	IP54	IP54	IP54	IP54
Protection degree EN60529/1 ambient inside	-	IP34	IP34	IP34	IP34
Weight	kg	60	60	63	63
Colour	-	RAL 7035	RAL 7035	RAL 7035	RAL 7035

### DRILLING TEMPLATE

VIEW FROM EXTERNAL OF ELECTRICAL BOX

