



INDUCTIVE SENSORS AC + AC/DC

TABLE OF CONTENTS

Designation code

How to read sensor designations

3

Circuit diagrams

Connection according to EN 60947-5-2

4

Sensors

Cylinder AC

5

Cylinder AC/DC

7

Square AC

9

Square AC/DC

11



INDUCTIVE SENSORS AC + AC/DC

DESIGNATION CODE

Example: **K J 10 - M 30 M B 45 - D P S - V1 - X0000**

1	2	3	4	5	6	7	8	9	10	11	12

1 = Working principle

A	Acoustic		
B	Acceleration sensor		
C	Capacitive		
D	Strain gauge sensor		
H	Hall-effect		
J	Inductive	JR	Inductive ring
		JF	Inductive surface
		JG	Inductive slot
		JD	Metaface
M	Magnetostrictive		
N	Inclination sensor		
R	Reed-contact		
W	Angle sensor		

2 = Switching distance / range

3 = Design

D	Ring housing
G	Cylindrical housing without thread
M	Cylindrical housing with metrical thread
Q	Square housing

4 = Housing diameter / edge length

5 = Housing material

A	Aluminium
E	Stainless steel
K	Plastic
M	Brass, nickel plated
T	PTFE

6 = Installation

B	Shielded
N	Non shielded

7 = Tube length

8 = Operating voltage

AZ	AC alternating current voltage
D	DC direct current voltage
VZ	AC/DC all voltages

9 = Type of output signal

AN	Analog	ANI	Current output
		ANU	Voltage output
N	NPN	CAN	CAN-bus interface
NA	Namur		
P	PNP		
Z	Two wire		

10 = Function

A	Changeover
I	Impulse output
Ö	N.C.
S	N.O.
U	Switchable

11 = Termination

V1	M8 screw-/snap-in
V2	M12 metal
V2/1	M12 plastic
V3	M5 metal
V4	Amphenol Tuchel
V6	Brad Harrison
V7	Valve connector type A
V8	M8 snap-in only
V9	Torson
V10	Valve connector type C
V11	AC connector 1/2" UNF
V12	M18 plastic
VE	Euchner connector
RS232	Data interface
PG	Thread joint PG
Mxx	Thread joint metrical

others as requested

12 = Additional marks

AM	Sensing face in centre
FE	Reduction 1 to steel / iron
HT	High temperature
NF	Reduction 1 to nonferrous metal
SF	Weld field immune
T	Enlarged temperature range
W	Angled sensing face / angled cable exit
X	Customized design with detailedled description



INDUCTIVE SENSORS AC + AC/DC

CIRCUIT DIAGRAMS

Circuit diagram for	Cable / clamp connection	Connector V1 ... V9
DPS DC PNP N.O.		
DPÖ DC PNP N.C.		
DPA DC PNP changeover		
DPU DC NO/NC switchable		
DNS DC NPN N.O.		
DNÖ DC NPN N.C.		
DNA DC NPN changeover		
DNU DC NO/NC switchable		
NA Namur EN 60947-5-6		
DZS DC two-wire N.O.		
DZÖ DC two-wire N.C.		
AZS/VZS AC/DC two-wire N.O.		
AZÖ/VZÖ AC/DC two-wire N.C.		
Analog		



INDUCTIVE SENSORS AC + AC/DC

CYLINDER AC

General data

Operating voltage U_b	20 ... 250V AC
Voltage frequency	50/60Hz
Voltage drop U_d	$\leq 5V$
Min. load current I_{emin}	5mA
Residual current I_r	$\leq 2mA$
Peak current	2A (20ms / 1Hz)
Max. switching frequency f	15Hz
Hysteresis H	$\leq 15\%$
Operating temperature T_a	-25°C ... +70°C
Temperature drift	$\leq 10\%$
Repeat accuracy R	$\leq 5\%$
Protection class	IP67
Switching state	LED
EMV-standard	according to EN60947-5-2
Housing material	brass, nickel-plated
Front cap	PCP
Connection	2m cable PVC 3 x 0,5mm ²



The drawings of these sensors are shown on the following page.

Other cable lengths as requested.

Selection chart

Article number	Designation	Mounting	Output signal	Switching distance in mm	Max. load current	Drawing (next page)
08317240500	KJ2-M12MB70-AZS	shielded	two-wire	2	300mA	A
08317240400	KJ2-M12MB70-AZÖ	shielded	two-wire	2	300mA	A
08317240700	KJ4-M12MN70-AZS	non shielded	two-wire	4	300mA	B
08317240900	KJ4-M12MN70-AZÖ	non shielded	two-wire	4	300mA	B
08317211200	KJ5-M18MB60-AZS	shielded	two-wire	5	300mA	C
08317211300	KJ5-M18MB60-AZÖ	shielded	two-wire	5	300mA	C
08317211500	KJ10-M18MN60-AZS	non shielded	two-wire	10	300mA	D
08317211700	KJ10-M18MN60-AZÖ	non shielded	two-wire	10	300mA	D
08317162600	KJ10-M30MB60-AZS	shielded	two-wire	10	300mA	E
08317162100	KJ10-M30MB60-AZÖ	shielded	two-wire	10	300mA	E
08317162700	KJ15-M30MN60-AZS	non shielded	two-wire	15	300mA	F
08317162300	KJ15-M30MN60-AZÖ	non shielded	two-wire	15	300mA	F



INDUCTIVE SENSORS AC + AC/DC

CYLINDER AC

Dimensions

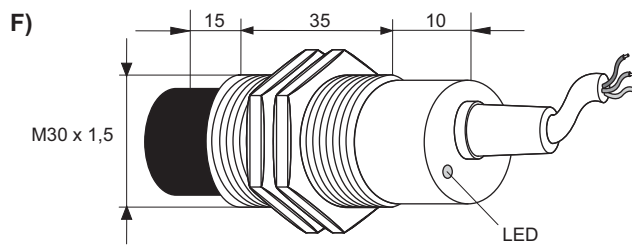
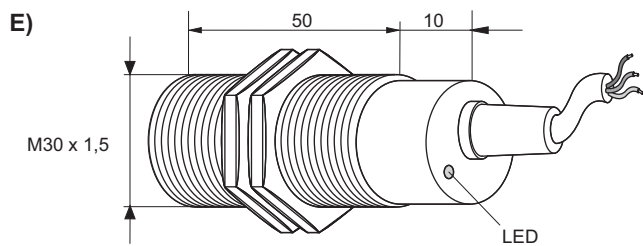
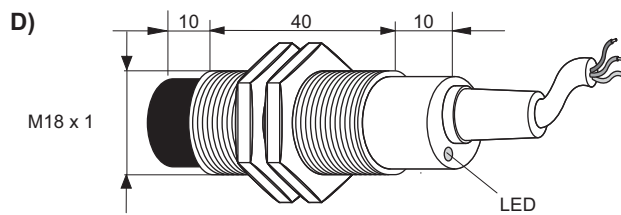
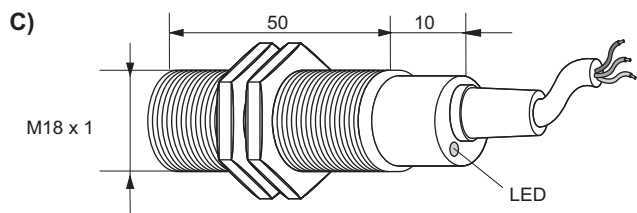
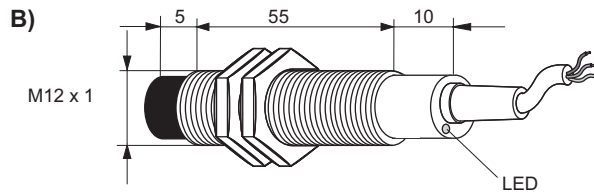
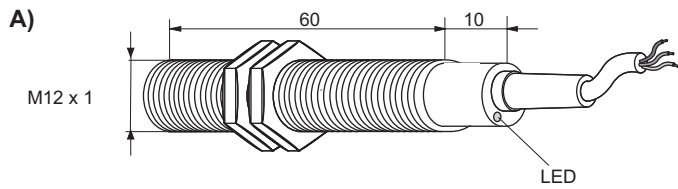



INDUCTIVE SENSORS AC + AC/DC

CYLINDER AC/DC

General data

Operating voltage U_b	20 ... 250V AC/DC
Voltage frequency	50/60Hz
Voltage drop U_d	$\leq 5V$
Min. load current I_{emin}	2mA
Max. load current I_e	350mA (M12 300mA)
Residual current I_r	$\leq 1,7mA$
Peak current	2A (20ms/1Hz)
Max. switching frequency f	30Hz
Hysteresis H	$\leq 15\%$
Operating temperature T_a	-25°C ... +70°C
Temperature drift	$\leq 10\%$
Repeat accuracy R	$\leq 5\%$
Protection class	IP67
Switching state	LED
EMV-standard	according to EN60947-5-2
Housing material	brass, nickel-plated
Front cap	PCP
Connection	2m cable PVC 3 x 0,5mm ²



The drawings of these sensors are shown on the following page.

Short circuit protection and overload protection locking. After removal of the short circuit the voltage supply has to be interrupted for approximately 2sec.

Other cable lengths as requested.

Selection chart

Article number	Designation	Mounting	Output signal	Switching distance in mm	Drawing (next page)
08317251200	KJ2-M12MB70-VZS	shielded	two-wire	2	A
08317251300	KJ2-M12MB70-VZÖ	shielded	two-wire	2	A
08317251500	KJ4-M12MN70-VZS	non shielded	two-wire	4	B
08317251700	KJ4-M12MN70-VZÖ	non shielded	two-wire	4	B
08317231200	KJ5-M18MB60-VZS	shielded	two-wire	5	C
08317231300	KJ5-M18MB60-VZÖ	shielded	two-wire	5	C
08317231500	KJ8-M18MN60-VZS	non shielded	two-wire	8	D
08317231700	KJ8-M18MN60-VZÖ	non shielded	two-wire	8	D
08317171200	KJ10-M30MB60-VZS	shielded	two-wire	10	E
08317171300	KJ10-M30MB60-VZÖ	shielded	two-wire	10	E
08317171500	KJ15-M30MN60-VZS	non shielded	two-wire	15	F
08317171700	KJ15-M30MN60-VZÖ	non shielded	two-wire	15	F



INDUCTIVE SENSORS AC + AC/DC

CYLINDER AC/DC

Dimensions

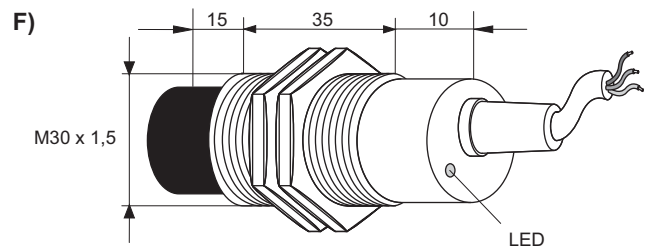
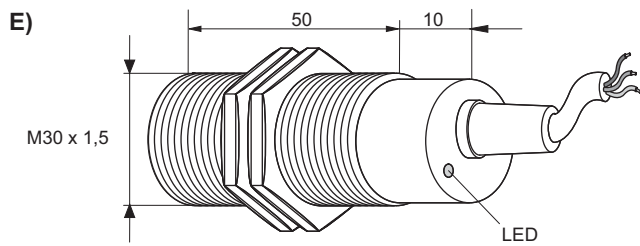
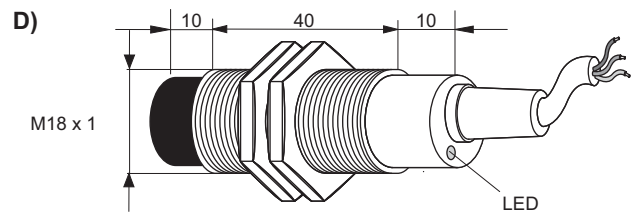
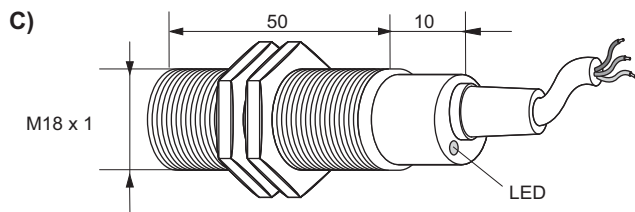
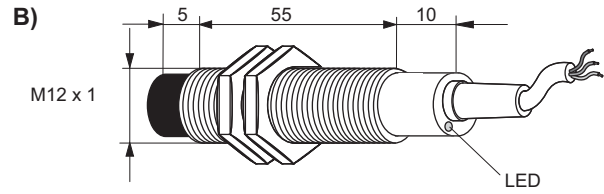
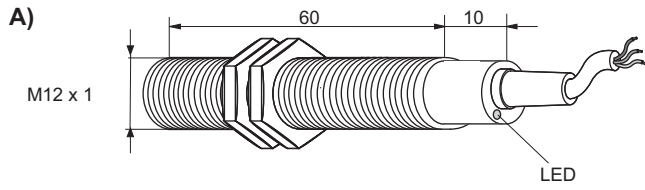



INDUCTIVE SENSORS AC + AC/DC

SQUARE AC

General data

	KJ15-Q40KB-AZU	KJ40-Q40KN-AZU	KJ50-Q80KN-AZS
Operating voltage U_b	20 ... 250V AC	20 ... 250V AC or DC	20 ... 250V AC
Voltage frequency	50/60Hz	50/60Hz	50/60Hz
Voltage drop U_d	$\leq 5V$	$\leq 5V$	$\leq 8V$ bei 400mA
Min. load current I_{emin}	5mA	5mA	5mA
Max. load current I_e	$\leq 500mA$	$\leq 500mA$	$\leq 400mA$
Residual current I_r	$\leq 2mA$	$\leq 2mA$	$\leq 1,8mA$
Peak current	8,0A (20ms)	8,0A (20ms)	5,0A (20ms)
Max. switching frequency f	15Hz	15Hz	25Hz
Output function	two-wire changeover	two-wire changeover	two-wire changeover
Hysteresis H	$\leq 15\%$	$\leq 15\%$	$\leq 15\%$
Operating temperature T_a	-25°C ... +70°C	-25°C ... +70°C	-25°C ... +70°C
Temperature drift	$\leq 10\%$	$\leq 10\%$	$\leq 10\%$
Repeat accuracy R	$\leq 5\%$	$\leq 5\%$	$\leq 5\%$
Protection class	IP67	IP67	IP67
Switching state	2 LED	2 LED	2 LED
EMV-standard	according to EN60947-5-2	according to EN60947-5-2	according to EN60947-5-2
Housing material	Trogamide T	Trogamide T	PBT Resin
Connection	clamps 1,5mm ²	clamps 1,5mm ²	clamps 1,5mm ²



The drawings of these sensors are shown on the following page.

Selection chart

Article number	Designations	Mounting	Switching distance in mm	Drawing (next page)
08317533000	KJ15-Q40KB-AZU	shielded	15	A
08317533200	KJ40-Q40KN-AZU	non shielded	40	A
08317551000	KJ50-Q80KN-AZS	non shielded	50	B



SQUARE AC

Dimensions

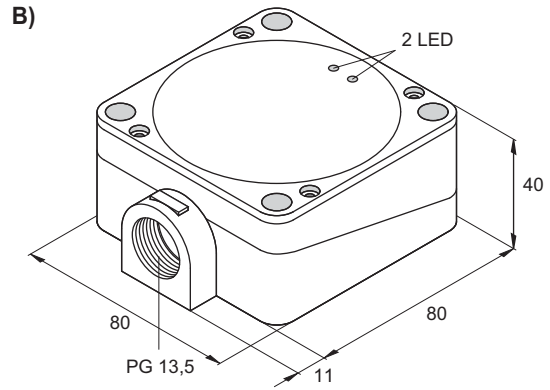
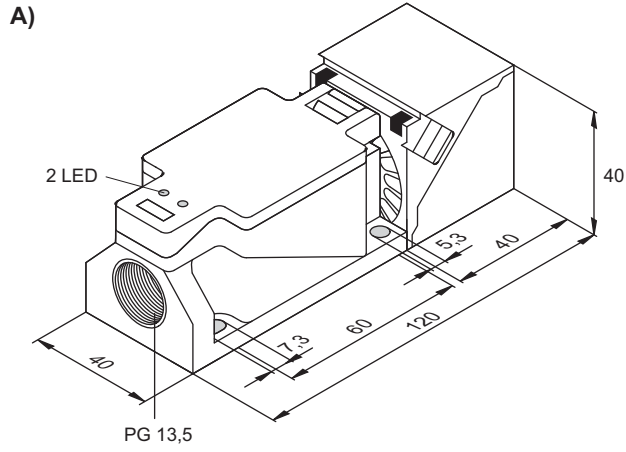



INDUCTIVE SENSORS AC + AC/DC

SQUARE AC/DC

General data

Mounting	shielded
Operating voltage U_b	20 ... 250V AC /DC
Voltage frequency	50/60Hz
Voltage drop U_d	$\leq 5V$
Min. load current I_{emin}	5mA
Max. load current I_e	400mA
Residual current I_r	$\leq 2mA$
Peak current	8A (20ms)
Max. switching frequency f	5Hz
Output function	two-wire changeover
Hysteresis H	$\leq 15\%$
Operating temperature T_a	-25°C ... +70°C
Temperature drift	$\leq 10\%$
Repeat accuracy R	$\leq 5\%$
Protection class	IP67
Switching state	2 LED
EMV-standard	according to EN 60947-5-2
Housing material	PA 6.6 GF30
Connection	clamps 1,5mm ²



Short circuit protection and overload protection locking. After removal of the short circuit the voltage supply has to be interrupted for approximately 2sec.

Selection chart

Article number	Designation	Switching distance in mm	Drawing
08317730000	KJ20-Q40KB-VZU	20	A
08317730200	KJ40-Q40KN-VZU	40	A

Dimensions

